

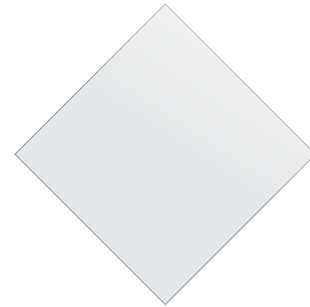

the binding company

since 1990



2024

The  
ultimate  
binding & customising  
**SOLUTIONS**  
for professionals  
and offices



## CATALOGUE

### binding systems

metalbind | office easy line  
c-bind | terbind | wire bind

### stamping system

goldcover

### photo books

pouch covers | lay-flat

### finishing tools

### customized products

made in Poland

[www.opus.pl](http://www.opus.pl)





# Contents

catalogue page

## **Metalbind**<sup>®</sup>

The ultimate binding solution for professionals

3

## **EASY LINE**

Smart, quick and simple binding system

11

## **dataPREDATOR**

Disk and flash drives shredder

14

## **C·BIND**<sup>®</sup>

Channel based binding system for professionals

15

## **terbind**<sup>®</sup>

Variable binding hot glued system for professionals and offices

19

## **Goldcover**

Embossing equipment for covers and channels

23

## **PHOTO BOOK**

**POUCH COVER** – customised covers for photo books

33

**LAY-FLAT** photo books

35

## **finishingTOOLS**

Creasing multi-functional machines

37

## **Multipress 52**

Pouching, Perforating, Folding and Wire binding

39

## **Customised Products**

41



the binding company



# Metalbind®

OPUS the binding company

The most recognized binding system in the world.

## Secure

Protecting your documents by clamping them between covers with a robust Metalbind channel to keep them safe.

## Universal

Coping with many types of original documents, maps, plans thick or thin, without fear of damage between covers solid or clear by a Metalbind channel, plus easy to de-bind with our special tool. No punching, no gluing.

## Popular

Used all over the world by small businesses to corporations, universities, schools and local governments for presentations. Storage of precious documents always looking perfect when needed.

## Elegant

Interchangeable impressive colourful covers, with or without windows, hard, soft or clear, richly embossed with gold or silver. Makes your presentations or reports stand out from all the others.

## Rugged

No fear of losing documents or misshaped presentations, using time after time lasting for a long time.

*Perfect Boom*  
KATALOG SPRZĘTU WYSTAWIENNICZEGO  
BY EXPO STOP

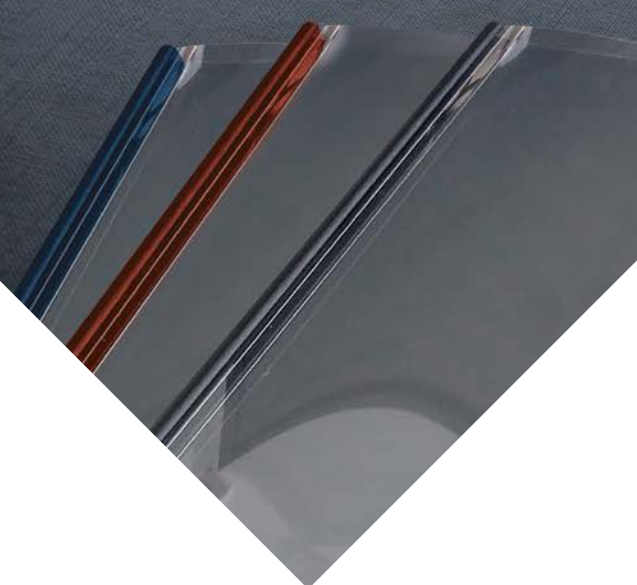

### Patented system:

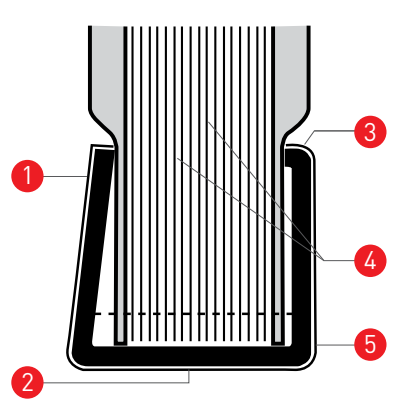

1. The back of the channel is bent in to hold covers and pages firmly.
2. The channel is lined with a special tape and then covered with embossed linen textured covering ready for hot print stamping.
3. The special shaped channel gives a perfect presentation of the documents.
4. No damage to pages by the channel.
5. The front face of the channel is never deformed.

### Patented COVERguide®

The special COVERguide system allows covers and documents to slide easily into the channel.

Special protrusions each end centres the document in the Metalbind channel precisely and protects against movement.

The design of the edges make the covers fit perfectly into the channel.



OPUS MB 300



Documents bound and embossed by using OPUS Metalbind & Goldcover machines.



OPUS MB 300  
-el office



## OPUS MB 300

The METALBIND MB300 is the flagship of OPUS binding machines for professionals.

Solid metal construction, ergonomic lever, power pressure indicator and ability to bind and debind up to 300 sheets of 80gsm paper makes it the favorite model of every copy shop in Europe.

Pressure indicator for large binding runs of documents gives a signal when the correct pressure for Metalbind channel is reached to avoid damage. 10 pressure levels, angled bed for ease of use, front binding slot.

You can easily bind thesis books, photobooks, business books, e.g. tenders, reports, proposals and much more in a few seconds.

## OPUS MB 300-el office



The METALBIND MB300-el office is an electric easy-to-use binding equipment, which binds and debinds documents up to 300 sheets of 80gsm paper.

One movement of the lever holds the channel in place and then binds your documents by pressing the buttons. Adjustable binding force and the LED display indicating binding pressure up to 2.3 tons. COVERguide system helps work fast when binding many documents.

## OPUS MBE 300

Electric version of the most popular Metalbind MB300 binding machine. It binds and debinds up to 300 sheets of 80gsm paper with ease and speed. The LCD display shows binding speed along with information regarding number of documents bound.

## Technical data

name	MB 300	MB 300-el office	MBE 300
formats	A5+, A4+, A4+ Squared and A3 landscape	A5+, A4+, A4+ Squared and A3 landscape	A5+, A4+, A4+ Squared and A3 landscape
binds / de-binds	up to 300 sheets*	up to 300 sheets*	up to 300 sheets*
dimensions (H x W x D) mm	270 x 410 x 362	270 x 465 x 320	270 x 410 x 362
net weight (kg)	19	21	45
gross weight (kg)	19,5	23,4	52
voltage (V-AC / 50 Hz)	-	230-240	230-240
maximum load (W)	-	60	200
pressure (T)	up to 2,3	up to 2,3	up to 2,3
features	- metal housing - steel frame - supplied with COVERguide system	- metal housing - steel frame - supplied with COVERguide system - precision step motor	- metal housing - steel frame - supplied with COVERguide system - precision step motor
see more			

\* Tested on 80 gsm paper

# Customers:

copy shops & book binders, schools & dean's offices,  
universities, corporations & private companies,  
public administration & institutions, archives & libraries

## Technical data

name	Atlas 190	Atlas 300
formats	A5+, A4+, A4+ Squared and A3 landscape	A5+, A4+, A4+ Squared and A3 landscape
binds / de-binds	up to 190 sheets*	up to 300 sheets*
dimensions (H x W x D) mm	180 x 435 x 320	310 x 522 x 256
net weight (kg)	16,1	16,3
gross weight (kg)	18,5	19,5
pressure (T)	up to 2,3	up to 2,3
features	- metal housing - steel frame - supplied with COVERguide system	- metal housing - steel frame - supplied with COVERguide system
see more		

\* Tested on 80g/m<sup>2</sup> paper

## OPUS Atlas 190

The METALBIND Atlas 190 is a professional binding machine which binds and debinds documents up to 190 sheets of 80gsm paper.

With a huge range of cover styles and sizes - this solidly built machine is great for binding pre-foiled covers or corporate printed covers with amazing simplicity. With no holes, glue or electricity you can bind a hardback book in just 10 seconds.

## OPUS Atlas 300 mono

The METALBIND Atlas 300 is a professional binding machine which binds and debinds documents up to 300 sheets of 80gsm paper using METALBIND hard covers / channels.

This makes it a perfect machine for the production of thesis books, photobooks, business books, ie. tenders, reports, proposals and much more. You can also bind A5, A4 and A3 landscape covers in the same machine.

Atlas 300 is the only model on the market that may optionally include stamping head – IMAGE PRESS.

Foiling Head, Fonts, Foils & Frames sold separately.

Image Press embossing effect  
(0.Hard Cover Classic)

### OPUS Image Press



### OPUS Atlas 300 mono



### OPUS Atlas 190



[more info](#)

## ACCESSORIES for Atlas 300 mono

### OPUS Image Press

Hot stamping and embossing device for Atlas 300 mono binding machine.

- Voltage: 230 V / 50Hz
- Average load: 100 W
- Maximum load: max 600 W
- Temperature range 20°C to 130°C in 5°C steps
- Illuminate power switch
- Red LED warning light come

binding machines

Image Press  
embossing effect  
(O.Hard Cover Classic)



frames  
& matrixes



OPUS Image  
Press

## ACCESSORIES for Image Press to use with fonts & matrixes:

### O.Frame GP 4/IP

One or multi-line frames for text composed out of O. FONT letters (4 mm / 5,5 mm / 9 mm / 16 mm).  
Also available frame for Matrix 27 x 180 x 10 mm and 16 mm / 4 mm fonts.

frame name	preview	lines	to use with
<b>O.Frame 1L9 GP4 / IP</b>		1	9 mm fonts
<b>O.Frame 1L5,5 GP4 / IP</b>		1	5,5 mm fonts
<b>O.Frame 2L9 GP4 / IP</b>		2	9 mm fonts
<b>O.Frame 1L9/1L5,5 GP4 / IP</b>		2	9 mm & 5,5 mm fonts

frame name	preview	lines	to use with
<b>O.Frame 1L9/2L4 GP4 / IP</b>		3	9 mm & 4 mm fonts
<b>O.Frame 3L5,5 GP4 / IP</b>		3	5,5 mm fonts
<b>O.Frame 3L4 GP4 / IP</b>		3	4 mm fonts
<b>O.Frame Matrix 1L16 / 1L4 GP4 / IP</b>		2	O.Matrix 27 x 180 x 10 mm & 16 / 4 mm fonts

### O.Matrix

OPUS offers a full service, design and manufacture with your logo or text ready to fit your Opus equipment. No additional parts or mounting tape, just fit it into your matrix frame. Now you are ready to hot print stamp your professional image.

### Ask for more info

We also offer different sizes of matrixes and fonts

frame name	preview	description
<b>O.Matrix 27 x 180 x 10 mm</b>		matrix for customised logo & text (to use with O.Frame GP4 / IP Matrix / 1L4)
<b>O.Matrix 50 x 180 x 10 mm</b>		matrix with handles for customised logo & text
<b>O.Matrix Base with handle GP4 / IP</b>		base plate with handles to stick magnesium or photo-polymer matrix on

## ACCESSORIES for Image Press to use with channels:

### O.Goldchannel Base GP4/IP

Accessory needed for hot print stamping  
on all Metalbind channels.



## SUPPLIES for Image Press:

### O.Foil Quick & Easy universal

Foil for hot stamping on covers and channels.  
Available colours: gold, silver, white, black, blue, green, maroon.  
Format: 90 x 180 mm. Packed 200 pcs per box.

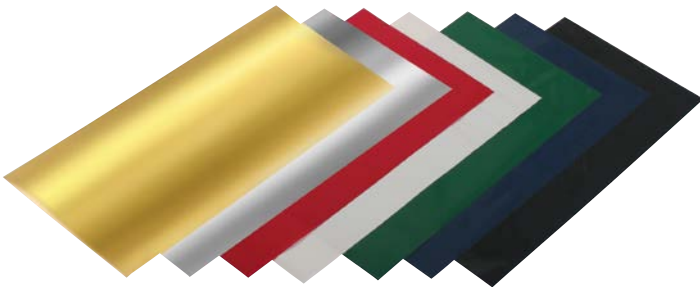

### O.FONT Latin

Latin alphabet font sets in 4 sizes (4 mm / 5,5 mm / 9 mm / 16 mm).  
Note! Ask for your national set (e.g. GB, DE, FR, ES etc.).  
Possible different font types:

O.FONT Latin	typeface preview
Standard	<b>A B C D E F G a b c d e f g</b>
Serif	<b>A B C D E F G a b c d e f g</b>
Serif Italic	<i><b>A B C D E F G a b c d e f g</b></i>
Block	<b>A B C D E F G H I J K</b>
Future	<b>A B C D E F G H I J K L M N P</b>
Ascetic	<b>A B C D E F G H I J K L M a b c d e f g h i j k l m</b>
Basic	<b>A B C D E F G H a b c d e f g h i j</b>
Techno	<b>A B C D E F G H a b c d e f g h</b>

# Metalbind®

OPUS the binding company

### Image Press Holder

The holder keeps the IMAGEPRESS safe and makes it easy  
to compose O.FONT typeface in the O.FRAME.



fonts

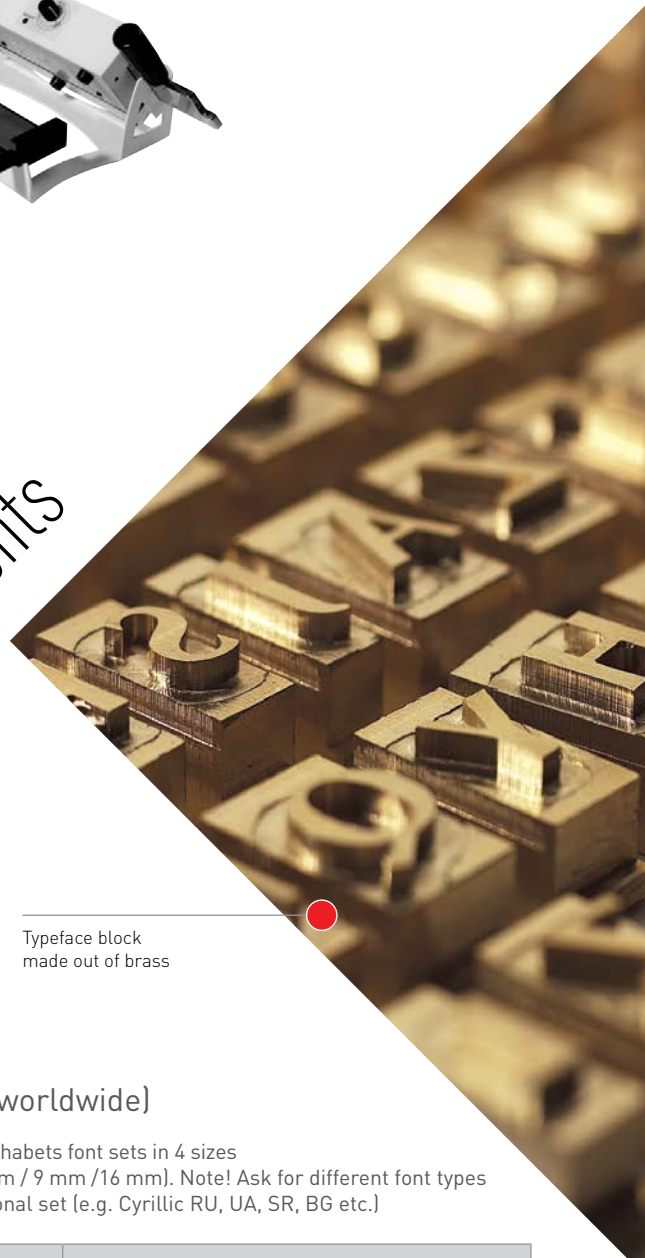

Typeface block  
made out of brass

### O.FONT (worldwide)

Worldwide alphabets font sets in 4 sizes  
(4 mm / 5,5 mm / 9 mm / 16 mm). Note! Ask for different font types  
and your national set (e.g. Cyrillic RU, UA, SR, BG etc.)

O.FONT (worldwide)	typeface preview
Hebrew Standard	<b>ב א ג ד ה ו ז ח ט י כ ל מ נ ס ע פ צ ק ר ש ת</b>
Cyrillic Standard	<b>А Б В Г Д Е а б в г д е</b>
Greek Standard	<b>Α Β Γ Δ Ε Ζ Η Θ α β γ δ ζ ε ς η θ</b>
Arabic Standard	<b>ا ب ج د ه و ز ح ط ق ك ل م ن ه ت</b>

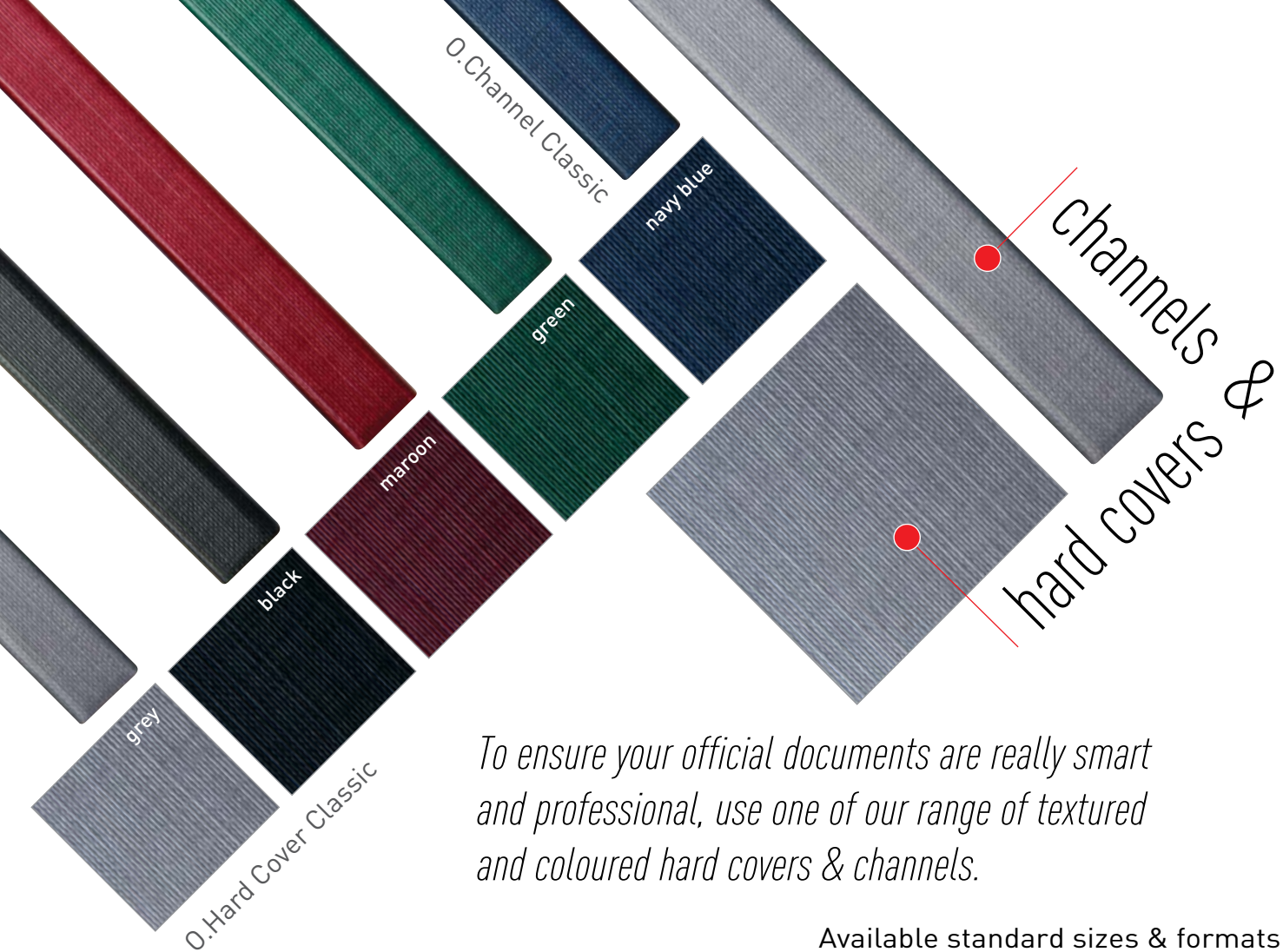

*To ensure your official documents are really smart and professional, use one of our range of textured and coloured hard covers & channels.*

Available standard sizes & formats

HARD COVERS		CHANNELS		
Sizes (mm)*	Boxed (pcs)	Sizes (mm)*	Lenght (mm)*	Boxed (pcs)
304 x 423 (A3+)	20	5 / 7 / 10 / 13 / 16 / 20 / 24 / 28 / 32	304	10
304 x 212 (A4+)	20	5 / 7 / 10 / 13 / 16 / 20 / 24 / 28 / 32	304	10
217 x 151 (A5+)	20	5 / 7 / 10 / 13 / 16 / 20 / 24 / 28 / 32	217	10
217 x 300 (A4 landscape+)	20	5 / 7 / 10 / 13 / 16 / 20 / 24 / 28 / 32	217	10

\* Ask for different sizes of covers and channels (special offer)

channel size selection table											
Channel size	1,5 mm	3 mm	5 mm	7 mm	10 mm	13 mm	16 mm	20 mm	24 mm	28 mm	32 mm
Binds max*	15 sheets	30 sheets	40 sheets	60 sheets	90 sheets	120 sheets	150 sheets	190 sheets	220 sheets	260 sheets	300 sheets



# SUPPLIES & MATERIALS:



OPUS the binding company

## 0.Hard Covers & 0. Channels (standard)

Name	description	cover preview	channel preview
<b>Classic</b>	Linen textured hard covers, available in following 5 colours: grey, black, maroon, green and navy blue. Designed to be used with 0.CHANNEL Classic.		
<b>Arctic</b>	Smooth satin finished hard covers available in pearl white colour. Designed to be used with 0.CHANNEL Arctic.		
<b>Business+</b>	Light textured finished hard covers available in silver colour. Designed to be used with 0.CHANNEL Business+.		
<b>Magister</b>	Textured hard covers available in 4 colours: maroon, black, navy blue and green. Designed to be used with 0.CHANNEL Magister.		
<b>Modern</b>	Satin finished hard covers available in black colour. Designed to be used with 0.CHANNEL Modern.		
<b>Mundial</b>	Leather textured hard covers available in 3 colours: black, red and navy blue. Designed to be used with 0.CHANNEL Mundial.		
<b>Europe</b>	Linen textured hard covers available in 4 colours: blue, green, maroon and beige. Designed to be used with 0.CHANNEL Europe.		
<b>Style</b>	Leather textured hard covers available in 4 colours: blue, maroon, green and red. Designed to be used with 0.CHANNEL Style.		

## 0.Hard Covers & 0. Channels (customised)



cover preview	description
	<p>We also offer customised sets of covers and channels.</p> <p>You can design the artwork (CMYK 4/0) yourself! Available A3+ (304 x 423 mm), A4+ landscape (304 x 212 mm) and A4+ portrait (217 x 300 mm) formats.</p> <p>To be used with 0.CHANNEL customised (length: 304 or 217 mm, size: 5 -32 mm)*</p> <p>* only if ordered with 0. HARD COVERS customised.</p>

## 0.Filling Sticky

Self-adhesive filling strips for when you do not have enough documents for the channel or when you add folded drawings, pictures, plans or maps etc.





the binding company

since 1990

**O. POUCH COVER**

hard covers with laminating pouch  
to use with personal artwork

**O. HARD COVER**

standard hard covers  
wide range of colours; customising  
possibilities: foil hot stamping, die cutting

**O. HARD COVER PERSONAL**

customised hard covers  
preprinted covers  
(CMYK offset printing)



**Why not** to judge  
a book  
by its cover?

**Metalbind®**

PREMIER BINDING SYSTEM  
MADE IN POLAND BY



# EASY LINE

in every office

## NEW!



## Fastest

complete process  
5 seconds only!

## The Easiest

easy to use desktop machine

## Most practical

ready to use fashionable  
transparent & semi matt soft covers

## Just a breakthrough!

The future of office binding

Patent  
protected system:

channel  
& binding jaw

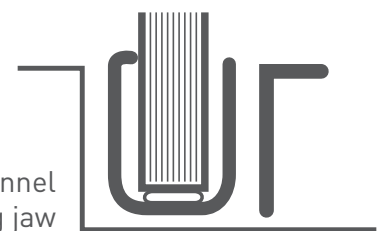



OPUS Easy 120



## OPUS EASY 120

Modern EASY LINE serie Metalbind machine for office use. It allows to bind up to 120 sheets. Easy, solid and stable (metal housing). Thanks to the special, patented binding jaw, the channel is evenly clamped. Note! Multi-system use: METALBIND & C-BIND

### Technical data

name	EASY 120
formats	A5+, A4+, A4+ Squared and A3 landscape
binds / de-binds	up to 120 sheets*
dimensions (H x W x D) mm	147 x 458 x 234
net weight (kg)	8,7
features	- metal housing - steel frame - colour: office grey - hot powder coated
see more	

\* Tested on 80 gsm paper

The fastest method in history  
**5 seconds** to bind!

### How to choose an Easy Cover?

cover size selection table						
Spine size	1-15 sheets	16-32 sheets	33-45 sheets	46-62 sheets	63-94 sheets	95-120 sheets
	1,5 mm	3 mm	5 mm	7 mm	10 mm	13 mm

## Easy 120

- patented binding jaw
- 3 tons pressure
- metal housing
- manual operation
- useful size selector
- small dimensions



# EASY LINE

by **METALBIND**  
OPUS the binding company

## Customers:

corporations & private companies

e.g. advertising agencies, notaries, lawyers, language schools,

training companies, design offices, public administration & institutions

### EASY OPEN

Creasing line helps to open flat



### METAL CHANNEL

holds the pages firmly

My company  
LOGO

### LASER PERSONALISATION

Order the customised brand logo & text marking

Covers **ready** for fast binding

Modern, easy to use and **appealing!**

## Easy Cover types

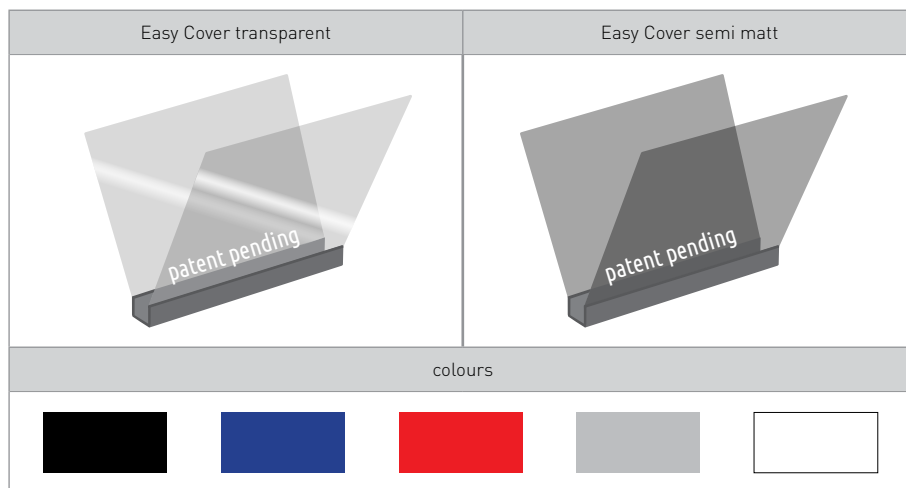

## Easy Cover

- 2 types of cover
- 6 spine sizes (1,5 - 13 mm)
- 5 colours
- useful creasing line
- narrow metal channel
- laser customisation



# data**PREDATOR**



Disk and flash drives shredder

## OPUS dataPREDATOR

A solid and convenient to use shredder of data media such as 2.5" and 3.5" disk drives (HDD and SSD) or USB flash drives. Small size and low weight allow you to move the device between data destruction sites. Very easy and light operation thanks to the eccentric mechanism. The device with a pressure of up to 2 tons destroys it with a replaceable spike or a knife attached to the device with a screw. A special pull-out drawer allows you to easily fit disks of various sizes.

### Technical data

name	dataPREDATOR
maximum disk height (mm)	27
maximum flash drive height (mm)	19
dimensions (H x W x D) mm	370 x 180 x 578
net weight (kg)	15
security level ISO / IEC 21964	E-2 / H-3

*Protect your data!*





OPUS the binding company

## Power of tradition

Traditional channel based binding system for school & university.

The highest durability and ease of use make it everlasting. Documentation looks noble and dignified.

Either professional service-providers or local student's workshop would appreciate the variety of consumables and possibilities of customization.

## Variety of use:

### **Service:**

master thesis's, doctoral dissertations, letters, albums, chronicles, books etc.

### **Office:**

business offers, agreements, price lists, menus, conference schedules, plans, rapports, certificates, diplomas, procedures etc.

### **School & University:**

congratulatory letters, diplomas, books, bachelor thesis's

and much more...

### **Channel binding system:**

Documents can be bound in premium quality hard & soft covers. The channel is hidden inside the spine.

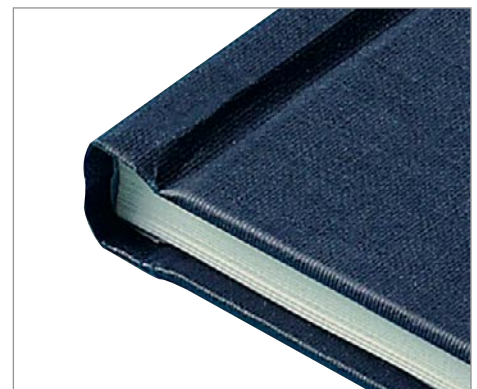

### **IMPORTANT!**

All the OPUS channel binding machines work under both METALBIND & C-BIND SYSTEMS.

It makes our solutions simple and universal.

Choose among variety of OPUS machines: Easy 120, ATLAS serie (190, 300 mono), MB 300, MB 300 el-office and MBE 300.

OPUS MBE 300



OPUS MB 300



OPUS MB 300  
-el office

OPUS Atlas 190



OPUS Image  
Press



How to choose  
a cover size?



OPUS  
Atlas 300  
mono

C-BIND cover size selection table		
cover size	channel size	Binds max*
AA	5 mm	soft cover 15-40 sheets hard cover 20-40 sheets
A	10 mm	41-90 sheets
B	13 mm	91-120 sheets
C	16 mm	121-150 sheets
D	20 mm	151-190 sheets
E	24 mm	191-220 sheets
F	28 mm	221-260 sheets
G	32 mm	261-300 sheets

\* Tested on 80 gsm paper

**Note!**

*All OPUS binding machines are multistandard:  
either METALBIND or C-BIND systems.  
See the description & technical data on pages 4-5*



OPUS  
Easy 120



# Customers:

copy shops & book binders  
universities, schools & dean's offices  
archives & libraries

max format:

**A4 +**

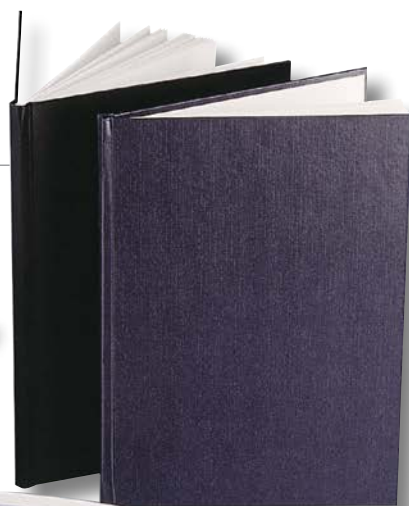

OPUS C-BIND  
hard covers



## The idea of channel binding:

BINDING	DE-BINDING
description	
Put the pages into the channel slot and squeeze the cover spine by using the METALBIND machine. Your documentation is ready!	Put the de-binding wedge into the bound documentation and squeeze out the channel (using the METALBIND machine). Then remove the pages.

## ACCESSORIES

If you want to use METALBIND machines to bind C-BIND covers it is necessary to equip them with the adequate adapters. There are also available de-binding wedges.



OPUS the binding company

adapter name	preview
<b>O.CB Insert for Atlas 190</b>	
<b>O.CB Pivot Inserts for Atlas 300 / MB 300</b>	
<b>O.CB Insert for MBE 300</b>	

de-binding wedge	preview
<b>O.CB Debinding tool for Atlas 190</b>	
<b>O.CB Debinding tool for Atlas 300 / MB 300</b>	

See the wide range of covers

OPUS offers C-BIND soft & hard covers

## SUPPLIES & MATERIALS:

### ● hard covers



OPUS the binding company

### C-BIND hard covers (standard)

Name	description	cover preview
<b>Classic</b>	Linen textured hard covers, available in following 5 colours: grey, black, maroon, green and navy blue.	
<b>Arctic</b>	Smooth satin finished hard covers available in pearl white colour.	
<b>Business+</b>	Light textured finished hard covers available in silver colour.	
<b>Magister</b>	Textured hard covers available in 4 colours: maroon, black, navy blue and green.	

Name	description	cover preview
<b>Modern</b>	Satin finished hard covers available in black colour.	
<b>Mundial</b>	Leather textured hard covers available in 3 colours: black, red and navy blue.	
<b>Europe</b>	Linen textured hard covers available in 4 colours: blue, green, maroon and beige.	
<b>Style</b>	Leather textured hard covers available in 4 colours: blue, maroon, green and red.	

### ● soft covers



OPUS C-BIND O.Softclear covers

### C-BIND soft covers (standard)

Name	description	cover preview
<b>Softclear</b>	Soft covers in 6 colours: maroon, navy blue, blue, black and green. Front cover transparent, back cover linen embossed.	
<b>Softplain</b>	Linen embossed soft covers. in 4 colours: black, grey, blue and maroon.	
<b>Softlux</b>	Soft covers made out of white, glossy cardboard.	

### C-BIND customised hard covers



cover preview	description
	We also offer customised C-BIND covers. You can design the artwork (CMYK 4/0) yourself! Available A4 (304 x 212 mm) formats and AA-G sizes.

### *Note:*

*Ask for more customization possibilities.*

### SUPPLIES:



### **O.Filling Sticky**

Self-adhesive filling strips for when you do not have enough documents for the channel or when you add folded drawings, pictures, plans or maps etc.



**terbind**<sup>®</sup>

OPUS the binding company

# the Easiest and Simplest way of BINDING in Soft & Hard COVERS

## What are the advantages?

Once you have the equipment, all you need to do is place the pages in either a hardback or paperback cover and stick the book in the machine. The heat inside the device will cause the adhesive to melt a bit, securing the pages.

## Where to use it?

Thermal binding is perfect for documents requiring a highly polished look.

Offers, advertising materials, price lists, manuals, plans, procedures, recipes, certificates, diplomas...

# what else?

PRACA  
MAGISTERSKA



## Thermal binding system:

Documents can be easily bound in quality hard & soft covers.  
The thermal glue is placed inside the spine.

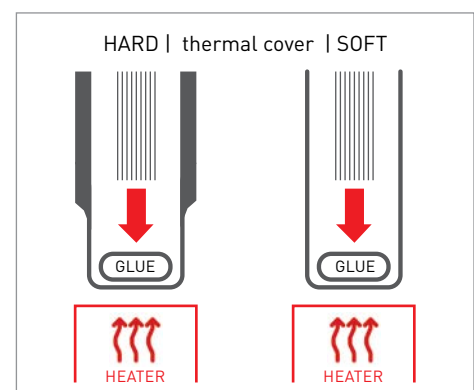

## IMPORTANT!

Choose among variety of soft and hard covers offered by OPUS Company.

We produce high-performance machines specially designed to use with OPUS consumables. See our DUO 500 Vario Temp.

## Technical data

name	DUO 500 Vario Temp
format max	A4, A3 landscape
binds max*	500 sheets (for soft covers) 250 sheets (for hard covers)
binding temperature	120°C / 145°C
power load max / average	600 W / 100 W
AC input	~230 V, 50/60 Hz, 2.6 A
warming time	approx. 3 minutes
dimensions (H x W x D) mm	165 x 440 x 165 mm
net weight (kg)	2,7
features	<ul style="list-style-type: none"> <li>- angled heater for quicker and better binding</li> <li>- photocell timer function</li> <li>LED lights</li> <li>- beeps when documents are ready</li> </ul>
See more	

\* Tested on 80 gsm paper\*

## OPUS DUO 500 Vario Temp



### DUO 500 Vario Temp

Award winning professional desktop thermal binding equipment. One machine for Hard, Soft & Clear covers. Easy to use. Paper size up to A3 Landscape. Binds up to 500 sheets at a time. Beeps when finished.

### Crimp & Cool

The equipment is to crimp and cool spines from the DUO 500 Vario Temp thermal binding hard covers.



## Customers:

*corporations & private companies, public administration & institutions, copy shops & book binders*

### O.THERMOLUX

White, soft thermal covers with transparent front.

### O.THERMOLINEN

Thermal soft covers PVC transparent front cover, textured back cover.

### O.DIPLOMAT Classic

Linen textured hard covers (Ask for customizing possibilities)



### O.OFFICE

Multi-coloured, soft thermal covers with transparent front cover

### O.ThermoPERSONAL (soft)

Offset printed soft covers with customized artwork



# SUPPLIES & MATERIALS:

## TERBIND O.DIPLOMAT hard covers (standard)

# terbind®

OPUS the binding company

max format: **A4 +**

● **hard covers**

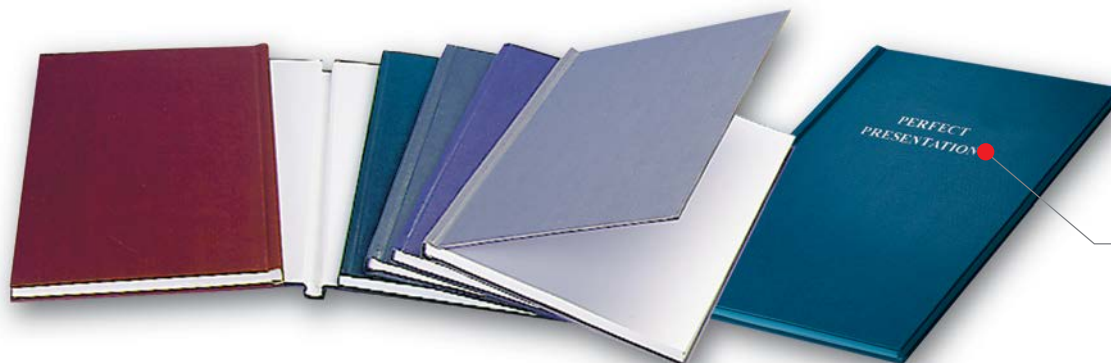

OPUS TERBIND O.DIPLOMAT Classic covers

**GOLDCOVER CUSTOMIZING**

Order your personal matrix containing the logo & text.

Name	description	cover preview
<b>O.DIPLOMAT Classic</b>	Linen textured thermal hard covers, available in following 5 colours: grey, black, maroon, green and navy blue.	
<b>O.DIPLOMAT Arctic</b>	Smooth satin finished thermal hard covers available in pearl white colour.	
<b>O.DIPLOMAT Business+</b>	Light textured finished thermal hard covers available in silver colour.	
<b>O.DIPLOMAT Modern</b>	Satin finished thermal hard covers available in black colour.	
<b>O.DIPLOMAT Europe</b>	Linen textured thermal hard covers available in 4 colours: blue, green, maroon and beige.	
<b>O.DIPLOMAT Style</b>	Leather textured thermal hard covers available in 4 colours: blue, maroon, green and red.	

How to choose a thermal cover size?

TERBIND cover size selection table		
spine size	SOFT COVER binds max*	HARD COVER binds max*
MINI	15 sheets	-
3 mm	30 sheets	25 sheets
4 mm	40 sheets	-
6 mm	60 sheets	50 sheets
8 mm	80 sheets	-
9 mm	-	80 sheets
10 mm	100 sheets	-
12 mm	120 sheets	120 sheets
15 mm	150 sheets	-
20 mm	200 sheets	-
25 mm	250 sheets	-
30 mm	300 sheets	-
35 mm	350 sheets	-
40 mm	400 sheets	-
45 mm	450 sheets	-
50 mm	500 sheets	-

\* Tested on 80 gsm paper

● **Need more?**

*Ask for other formats, veneers or customizing possibilities.*

**TERBIND soft covers (standard)**

Name	description	cover preview
<b>0.Office</b>	Thermal soft covers PVC transparent front, leather textured back. 6 colours: white, blue, red, maroon, green, black and navy blue.	
<b>0.Thermolux</b>	Thermal soft covers PVC transparent front, glossy back. Colour: white	
<b>0.Thermomat</b>	Thermal soft covers PVC transparent front, matt back. Colour: white	
<b>0.Thermo- linen</b>	Thermal soft covers PVC transparent front, fabric textured back. Colours: navy blue, black, green, maroon.	
<b>0.Thermolin- en Plain</b>	Thermal soft covers fabric textured front & back. Colours: navy blue, black, green, maroon.	
<b>0.Thermotop Double Clear</b>	Thermal soft covers transparent front & back with a metal channel covered with leather texture. Available in several colours.	
<b>0.Neocover</b>	Thermal soft covers transparent front & back with minimum spine coverage of the front page. Available in several colours.	

● **soft covers**

**TERBIND customized soft covers**

***0.Thermo PERSONAL***

*Create your own design!*



We also offer customised soft thermal covers. You can design the artwork (CMYK 4/0 or CMYK 4/4) yourself! Available A4 (304 x 212 mm) format and all (MINI - 50 mm) sizes.





**Goldcover**

OPUS the binding company

The perfect  
equipment and finish  
for you documents!

**Goldcover system enables you to add personalised foil to your products.**

**Uses:**

master thesis's, doctoral dissertations, albums, chronicles, books, congratulatory letters, diplomas, books, bachelor thesis's, menus etc.

Create not only the personal matrix, but compose the text as well. Express yourself, communicate with your customer, close, friend!

**Hot stamp foiling & embossing:**

heavy duty press module together with a heater allow user to foil & emboss on many kinds of material. We recommend OPUS hard covers (Metalbind, C-Bind).

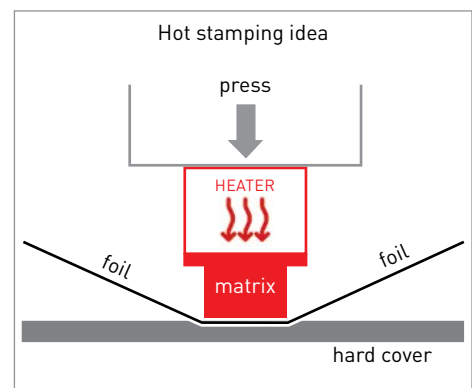

**IMPORTANT!**

Choose among variety of GOLDCOVER machines: NamePRESS for personal use, Goldpress 4+, 5 for office and Masterpress serie for professionals.

**NEW machines!**

# Name PRESS

OPUS  
NamePRESS. **NEW** design!

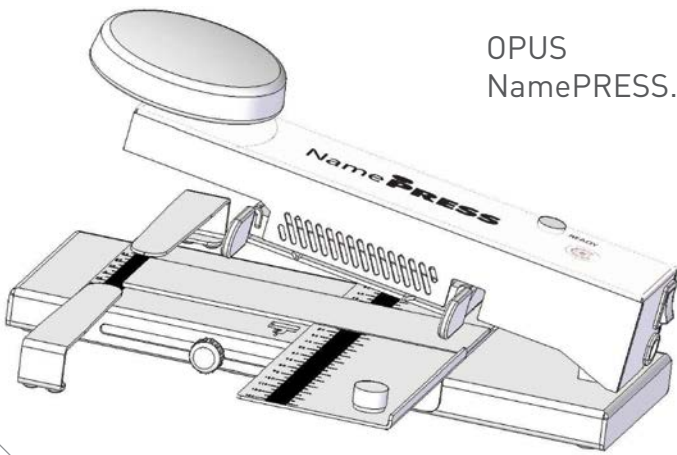

## NAMEPRESS PERSONALISATION

Add your custom text  
(e.g. name, surname)  
to the document  
(notebook, diary etc.)

## Technical data

name	NamePRESS
power	AC 230 V 50/60 Hz (0.5 A)
rated current	100 W
dimensions (H x W x D) mm	135 x 280 x 280 mm
net weight (kg)	2,9
features	<ul style="list-style-type: none"> <li>- steel housing</li> <li>- frame for fonts</li> <li>- movable bed with ruler</li> <li>- "READY" led indicator</li> </ul>

## OPUS Namepress

NEW, enhanced version of OPUS "palm" press machine.  
Small, compact and portable but fully professional.  
We recommend it for foil stamping custom text and captions on handy books  
(e.g. notebook, calendars, diaries etc.)  
Specially designed two-lines frame allows user to hot stamp  
a short personal inscription (e.g. name & surname).

## Customers:

*copy shops, book binders, notebook producers & suppliers  
digital printing houses & advertising agencies*

## ACCESSORIES

### 0.Frame NamePRESS & BASIC font set 5.5 mm

2-line frame for text composed out of 0. FONT letters 5,5 mm.  
We recommend 0.FONT LATIN BASIC typeface (see the example).  
**NOTE!** Ask for other font styles (STANDARD, SERIF, BLOCK etc.)

frame name	preview	lines	to use with
<b>0.miniFrame 2L5,5</b>	<p><b>NEW!</b></p>	3	5,5 mm fonts

● **NamePRESS effect**  
*See the example of text composed  
by using 5,5 mm BASIC typeface font*

actual size

Peter's NOTEBOOK  
Paperworld 2022



## Goldcover

OPUS the binding company

### OPUS Goldpress 4+

Professional hot print stamping machine used for customizing all types of hard and soft covered presentations with many possibilities. You can also use it for printing on the covered METALBIND channels. See the table with accessories. Available many font & matrix frames, typeface styles and foils.

### OPUS Goldpress 5

The NEW easy to use bigger and better Goldpress 5, perfect for your hot print foiling, embossing for small or larger text and logos, for all types of covers: hard, soft, plastic, leather, textured surfaces. Now you can print **on the whole length of the covered channels** from the Metalbind system due to the openings on each side, letting you move the channel to any position. The Goldpress 5 gives you a **100 x 200 mm** surface to print with plus more opportunities.

With the Goldchannel base set\* you can foil on Metalbind channels or Channelbind spines.

\* sold separately

### Technical data

name	Goldpress 4+	Goldpress 5
max cover width with / without the side stop (mm)	265 / 305	265 / 305
rated voltage*	230 V / 50 Hz	230 V / 50 Hz
max matrix size (H x W)	50 x 180, 80 x 110	<b>100 x 200</b>
max power consumption	500 W	600 W
rated power consumption	80 W	80 W
operating temperature	~100°C	~100°C
temperature stabilization	microprocessor	microprocessor
temperature adjustment range	50 - 150°C	20 - 150°C
pressure (T)	2	2
dimensions (H x W x D) mm	278 x 362 x 546	280 x 362 x 548
net weight (kg)	24,6	28,6
features	- metal housing - LCD display - drawer for accessories	- metal housing - LCD display - drawer for accessories
see more		

\* 110 - 120 V / 50 - 60 Hz version also available



Examples of foil stamping & embossing on the OPUS standard hard covers.

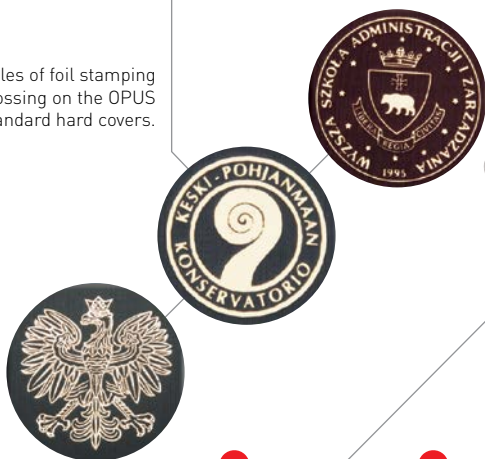

4+

5

# Gold PRESS

OPUS Goldpress 4+



[more info](#)

OPUS Goldpress 5





# GP4+

● **ACCESSORIES**  
for Goldpress 4+ to use with  
fonts, matrixes and channels:

## O.Frame GP4/IP

One or multi-line frames for text composed out of O. FONT letters  
(4 mm / 5,5 mm / 9 mm). Also available frame for Matrix  
27 x 180 x 10 mm and 16 mm / 4 mm fonts.

frame name	preview	lines	to use with
<b>O.Frame 1L9 GP4 / IP</b>		1	9 mm fonts
<b>O.Frame 1L5,5 GP4 / IP</b>		1	5,5 mm fonts
<b>O.Frame 2L9 GP4 / IP</b>		2	9 mm fonts
<b>O.Frame 1L9/1L5,5 GP4 / IP</b>		2	9 mm & 5,5 mm fonts

frame name	preview	lines	to use with
<b>O.Frame 1L9/2L4 GP4 / IP</b>		3	9 mm & 4 mm fonts
<b>O.Frame 3L5,5 GP4 / IP</b>		3	5,5 mm fonts
<b>O.Frame 3L4 GP4 / IP</b>		3	4 mm fonts
<b>O.Frame Matrix /1L16 / 1L4 GP4 / IP</b>		2	O.Matrix 27 x 180 x 10 mm & 16 mm / 4 mm fonts

## O.Matrix

OPUS offers a full service, design and manufacture with your logo or text ready to fit your Opus equipment.  
Now you are ready to hot print stamp your professional image.

frame name	preview	description
<b>O.Matrix 27 x 180 x 10 mm GP</b>		matrix for customised logo & text (to use with O.Frame GP4 / IP Matrix / 1L4)
<b>O.Matrix 50 x 180 x 10 mm GP</b>		matrix with handles for customised logo & text
<b>O.Matrix Base with handle GP4 / IP</b>		base plate with handles to stick magnesium or photo-polymer matrix on

## O.Foil Quick & Easy universal

Foil for hot stamping on covers and channels.  
Available colours: gold, silver, white, black, blue, green, maroon.  
Formats: 90 x 180, 130 x 210 mm. Packed 200 pcs per box.

## O.Goldchannel Base GP4

Accessory needed for hot print stamping on Metalbind channels.

name	preview
<b>O.Goldchannel Base GP4</b>	

## SUPPLIES for Goldpress 4+/Goldpress 5:

name	preview
<b>O.Foil Quick &amp; Easy universal 90 x 180 mm (for GP 4+)</b>	
<b>O.Foil Quick &amp; Easy universal 130 x 210 mm (for GP 5)</b>	

**ACCESSORIES** ●  
for Goldpress 5 to use with  
fonts, matrixes and channels:

**Note!** Ask for GP5 custom matrix sizes.

## O.Matrix Bases GP5/MP02

Two kinds of base for mounting matrixes/logos:  
- **O.Matrix Base GP5/MP02** - base for sticking matrixes/logos  
- **O.Screw Matrix Base GP5/MP02** - plate with threaded holes for screwing matrixes/logo.

preview	
	
<b>O.Matrix Base GP5/MP02</b>	<b>O.Screw Matrix Base GP5/MP02</b>

## O.Goldchannel Base GP5

Accessory needed for hot print stamping on all Metalbind channels for OPUS document binding systems on GOLDPRESS 5.

name	preview
<b>O.Goldchannel Base GP5</b>	









## O.FONT Latin

Latin alphabet font sets in 4 sizes (4 mm / 5,5 mm / 9 mm / 16 mm).  
Note! Ask for your national set (e.g. GB, DE, FR, ES etc.).  
Possible different font types:

O.FONT Latin	typeface preview
<b>Standard</b>	<b>A B C D E F G a b c d e f g</b>
<b>Serif</b>	<b>A B C D E F G a b c d e f g</b>
<b>Serif Italic</b>	<i><b>A B C D E F G a b c d e f g</b></i>
<b>Block</b>	<b>A B C D E F G H I J K</b>
<b>Future</b>	<b>A B C D E F G H I J K L M N P</b>
<b>Ascetic</b>	<b>A B C D E F G H I J K L M a b c d e f g h i j k l m</b>
<b>Basic</b>	<b>A B C D E F G H a b c d e f g h i j</b>
<b>Techno</b>	<b>A B C D E F G H a b c d e f g h</b>

## O.Frame GP5/MP02

Multi-line frames for text composed out of O. FONT letters (4 mm / 5,5 mm / 9 mm / 16 mm) to use together with O.Master Frame.  
NOTE! Ask for custom matrix in above-mentioned sizes.

frame name	preview	description
<b>O.Master Frame + Holder GP5</b>		Master frame for custom matrixes or typeface font frames (standard equipment) installed on O.Master Frame Holder GP5
<b>O.Frame 5L5,5 GP5 / MP02</b>		5-lines frame for 5,5 mm fonts
<b>O.Frame 5L4 GP5 / MP02</b>		5-lines frame for 4 mm fonts
<b>O.Frame 3L9 GP5 / MP02</b>		3-lines frame for 9 mm fonts
<b>O.Frame 1L9/2L4 GP5 / MP02</b>		3-lines frame for 9 mm & 4 mm fonts
<b>O.Frame 1L9/1L5,5 GP5 / MP02</b>		2-lines frame for 9 mm & 5,5 mm fonts
<b>O.Frame 1L16/1L5,5 GP5 / MP02</b>		2-lines frame for 16 mm & 5,5 mm fonts
<b>O.Frame 1L16/1L4 GP5 / MP02</b>		2-lines frame for 16 mm & 4 mm fonts

**Note!** OPUS font sets fit to all GOLDCOVER machines. Choose the suitable size and frame.

[more info](#) ➔

## O.FONT (worldwide)

Worldwide alphabets font sets in 4 sizes (4 mm / 5,5 mm / 9 mm / 16 mm).  
Note! Ask for different font types and your national set (e.g. Cyrillic RU, UA, SR, BG etc.).

O.FONT (worldwide)	typeface preview
<b>Hebrew Standard</b>	<b>ב א ם ן ף ץ ז ת ה ו</b>
<b>Cyrillic Standard</b>	<b>А Б В Г Д Е а б в г д е</b>
<b>Greek Standard</b>	<b>Α Β Γ Δ Ε Ζ Η Θ α β γ δ ζ ε ς η θ</b>
<b>Arabic Standard</b>	<b>ك ح د ر ز ع ف ط ق ت ث</b>

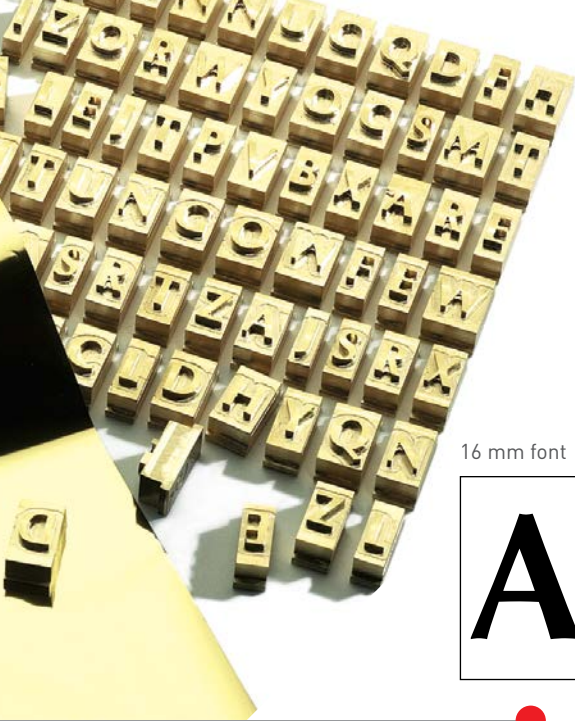

# All about the *OPUS O.FONT*

Fonts are made out of brass and are offered in **MASTER SETS** in specified, national language (e.g. GB, DE, FR, ES etc.), font style (e.g. Standard, Serif, Serif Italic, Block)\* and size: 4 mm / 5,5 mm / 9 mm / 16 mm. Font sets include small and CAPITAL letters\*\*.

Fonts are being installed on the stamping machine heater in frames (O.FRAME).

Master Sets are stored in containers:

- **O.FONT CONTAINER** (universal container for all language version)
- **O.NATIONAL FONT CONTAINER** (container for specified, national language (GB, DE etc.))

16 mm font



## O.FONT

Look for your national language:

[www.opus.pl](http://www.opus.pl)

### O.FONT MASTER SET GB STANDARD (4 mm / 5,5 mm / 9 mm)

The comparison table below shows the contents of O.FONT Master Set GB Standard in three sizes. Each set consists of CAPITAL, small letters\*\* and Spec-Numbers in one chosen size (e.g. 4 mm / 5,5 mm / 9 mm). This set also available in 16 mm size.

O.FONT sizes			O.FONT in the O.FRAME (example)
4 mm / 5,5 mm / 9 mm			
O.FONT main styles*			
<b>A B C D E F G a b c d e f g</b> Standard		<b>A B C D E F G a b c d e f g</b> Serif	
<b>A B C D E F G a b c d e f g</b> Serif Italic		<b>A B C D E F G H I J K</b> Block	
O.FONT containers			
O.FONT CONTAINER		O.FONT NATIONAL CONTAINER	

O.FONT MASTER SET GB STANDARD CAPITAL letters contents (pcs)																										
font	A	B	C	D	E	F	G	H	I	J	K	L	M	N	O	P	Q	R	S	T	U	V	W	X	Y	Z
Master Set GB 4 mm	4	2	4	2	4	2	4	2	2	4	2	2	2	2	2	2	4	4	4	2	2	2	2	4	2	
Master Set GB 5,5 mm	4	2	4	2	4	2	4	2	2	2	2	2	2	2	2	2	4	4	4	2	2	2	2	4	2	
Master Set GB 9 mm	10	4	4	4	10	4	4	6	10	2	4	6	4	8	8	4	2	8	8	8	4	2	2	2	6	4

O.FONT MASTER SET GB STANDARD small letters contents (pcs)																										
font	a	b	c	d	e	f	g	h	i	j	k	l	m	n	o	p	q	r	s	t	u	v	w	x	y	z
Master Set GB 4 mm	16	6	6	6	16	4	4	6	14	2	4	12	4	16	12	4	2	14	10	10	4	2	2	2	6	4
Master Set GB 5,5 mm	12	4	4	4	10	4	4	4	10	2	4	10	4	14	10	4	2	10	4	10	4	2	2	2	4	4

O.FONT MASTER SET GB STANDARD SPEC-NUM contents (pcs)																													
font	0	1	2	3	4	5	6	7	8	9	W	'	.	,	/	!	-	&	„	”	“	...	:	;	@	?	(	)	S P E C I A L
Master Set GB 4 mm	6	3	4	4	3	3	3	3	3	3	1	1	4	3	4	1	4	1	1	1	1	1	1	1	1	1	1	1	12
Master Set GB 5,5 mm	6	3	4	4	3	3	3	3	3	3	1	1	4	3	4	1	4	13	1	1	1	1	1	1	1	-	-	8	
Master Set GB 9 mm	5	2	3	3	2	2	2	2	2	2	-	1	3	2	-	1	2	1	1	1	-	1	1	1	-	1	-	8	

\* Ask for other font styles (e.g. FUTURE, ASCETIC, BASIC etc.)  
\*\* FONT sets 9 mm included CAPITAL letters only



# The perfect equipment and finish for you documents!

## Goldcover

US the binding company

### Technical data

### OPUS Masterpress 02

The perfect mid-range foiling solution. The NEW Masterpress 02 manual machine is compact, lighter and ergonomically designed to be more comfortable to use. Increased height between the table & the heater gives flexibility & ease of operation. Re-designed handle - allowing for right or left hand use. Square heater head - 20x20cm - allows access from side or front, making foil set up much easier & faster.

Slide out table enables easier positioning of small items - eg. business cards - more accuracy = less waste. Compatible with all Goldpress 5 matrixes & accessories.

### OPUS Masterpress EMD

The Electric Masterpress is a vertical foil blocking machine with an A4 heat block area. The Masterpress can be used with magnesium, brass or copper matrixes - attached with heat tape or screws. It can also be used with Opus brass letters for easy type-setting - perfect for names, titles, thesis books, year books, photo books and more. Perfect for foiling on case covers, books, cards & much more.

The electronic display shows adjustable temperature (50 to 150 deg C), pressure time, pressure, foil length, height control & counter.

With up to 5 tons of pressure, the foiling machine is a versatile option for small print firms new to foiling or a short run vertical print option for the experienced foiling company with larger machines.

name	Masterpress 02	Masterpress EMD
rated voltage*	230 V / 50 Hz	230 V / 50 Hz
max matrix size (H x W)	200 x 200	218 x 308
max power consumption	2 kW	2 kW
rated power consumption	0,8 kW	1,5 kW
operating temperature	~100°C	~100°C
temperature stabilization	microprocessor	microprocessor
temperature adjustment range	30 - 190°C	30 - 190°C
pressure max (T)	5	5
max foil width (mm)	230	230
dimensions (H x W x D) mm	1015 x 820 x 525	280 x 362 x 548
net weight (kg)	80	138
features	- stamping force regulation - LCD display - possibility to install matrixes and type fonts across and along the machine - sliding worktable	- stamping force regulation - LCD display - possibility to install matrixes and type fonts across and along the machine - adjustable stroke
see more		

\* 110 - 120 V / 50 - 60 Hz version also available

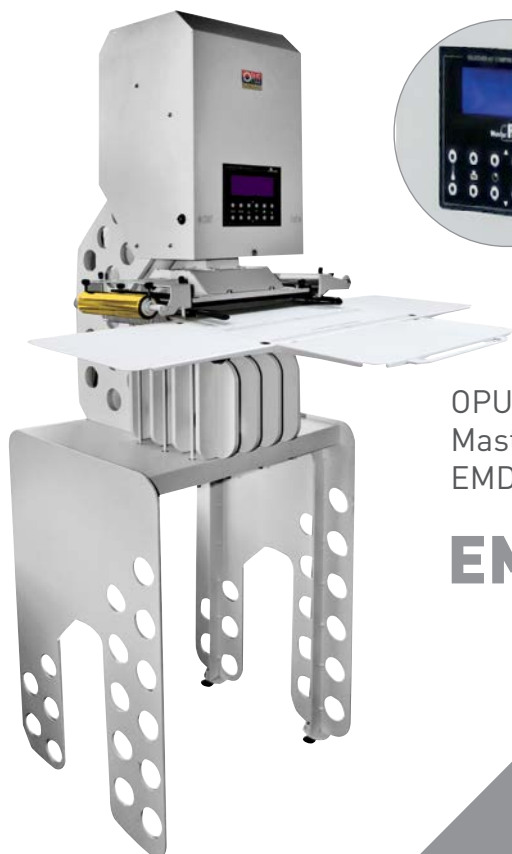

OPUS Masterpress EMD

EMD



OPUS Masterpress 02

#### LCD DISPLAY

shows adjustable temperature (50 to 150 deg C), pressure time, pressure, foil length, height control & counter.

02

# Master PRESS



*Barbara & Jonathan*

## Note!

*Ask for Masterpress series custom matrix or font Master set. There are a lot of sizes and styles. Create your vision. The sky is the limit!*

## ACCESSORIES for Masterpress 02 to use with fonts and matrixes.

### O.Frame GP5\*/MP02

Multi-line frames for text composed out of O. FONT letters (4 mm / 5,5 mm / 9 mm / 16 mm) to use together with O.Master Frame. NOTE! Ask for custom matrix in above-mentioned sizes.

frame name	preview	description
<b>O.Master Frame + Holder GP5</b>		Master frame for custom matrixes or typeface font frames (standard equipment) installed on O.Master Frame Holder GP5
<b>O.Frame 5L5,5 GP5 / MP02</b>		5-lines frame for 5,5 mm fonts
<b>O.Frame 5L4 GP5 / MP02</b>		5-lines frame for 4 mm fonts
<b>O.Frame 3L9 GP5 / MP02</b>		3-lines frame for 9 mm fonts
<b>O.Frame 1L9/2L4 GP5 / MP02</b>		3-lines frame for 9 mm & 4 mm fonts
<b>O.Frame 1L9/1L5,5 GP5 / MP02</b>		2-lines frame for 9 mm & 5,5 mm fonts
<b>O.Frame 1L16/1L5,5 GP5 / MP02</b>		2-lines frame for 16 mm & 5,5 mm fonts
<b>O.Frame 1L16/1L4 GP5 / MP02</b>		2-lines frame for 16 mm & 4 mm fonts

### O.Matrix Bases GP5\*/MP02

Two kinds of base for mounting matrixes/logos:

- **O.Matrix Base GP5/MP02** - base for sticking matrixes/logos
- **O.Screw Matrix Base GP5/MP02** - plate with threaded holes for screwing matrixes/logo.

preview	
<b>O.Matrix Base GP5/MP02</b>	<b>O.Screw Matrix Base GP5/MP02</b>

Universal accessories for Masterpress 02 & EMD to use with channels:

### O.Goldchannel Base MP series\*\* & EMD

Accessory needed for hot print stamping on all Metalbind channels for OPUS document binding systems on GOLDPRESS 5.

name	preview
<b>O.Goldchannel Base MP01 / MPEMD</b>	
<b>O.Goldchannel Base MP01 / MPEMD LONG</b>	









\* Frames and bases for Masterpress 02 also fit the Goldpress 5 machine

\*\* Masterpress 02 is the new, enhanced version of OPUS Masterpress 01 machine.

## ACCESSORIES for Masterpress EMD to use with fonts, matrixes. Supplies for Masterpress 02 & EMD

### 0.Frame MP EMD

Multi-line frames for text composed out of O. FONT letters  
(4 mm / 5,5 mm / 9 mm / 16 mm) to use together with O.Master Frame.  
NOTE! Ask for custom matrix in above-mentioned sizes.

frame name	preview	description
<b>0.Master Frame MP EMD</b>		Master frame for custom matrixes or typeface font one-line frames (standard equipment)
<b>0.Matrix Framework MP EMD</b>		Frame guides for matrixes
<b>0.Long Frame MP EMD</b>		4-lines Master frame to use with OPUS O. Font (1 line 9 mm / 2 lines 16 mm / 1 line 5,5 mm)
<b>0.Single Frame 4 mm MP EMD</b>		5 pcs set of 1-line frames for 4 mm fonts
<b>0.Single Frame 5,5 mm MP EMD</b>		5 pcs set of 1-line frames for 5,5 mm fonts
<b>0.Single Frame 9 mm MP EMD</b>		5 pcs set of 1-line frames for 9 mm fonts
<b>0.Frame 3L4 MP EMD</b>		3-lines frame for 4 mm fonts
<b>0.Frame 3L5,5 MP EMD</b>		3-lines frame for 5,5 mm fonts
<b>0.Frame 3L9 MP EMD</b>		3-lines frame for 9 mm fonts

### 0.Matrix Bases Masterpress EMD

Two kinds of base for mounting matrixes/logos:  
- **0.Matrix Base MP EMD** - base for sticking matrixes/logos  
- **0.Screw Matrix Base MP EMD** - plate with threaded holes for screwing matrixes/logo.

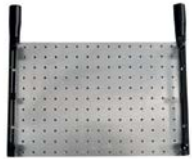
preview	
	
<b>0.Matrix Base MP EMD</b>	<b>0.Screw Matrix Base MP EMD</b>

**Note!** OPUS font sets fit to all GOLDCOVER machines. Choose the suitable size and frame.

● ————— OPUS O.FONT more info (page 29-30)

## SUPPLIES for Masterpress 02 & EMD:

### 0.Foil 18 cm x 122 m / 22 cm x 122 m

Special foil packing in rolls for hot stamping on covers and channels.  
Available colours: gold, silver, white, black, blue, green.  
Formats: 18 cm x 122 m (for Masterpress EMD) and 22 x 122 m (for Masterpress 02). Packed 200 pcs per box.

name	preview
<b>0.Foil :</b> - 18 cm x 122 m - 22 cm x 122 m	

**218 X 308 MASTERPRESS EMD  
CUSTOM MATRIX**

The effect of hot stamping & embossing  
on the OPUS O.Hard Cover Classic

OPUS Goldcover - foil stamping system

## ***The size matters!***

*OPUS offers a large variety of accessories,  
custom matrixes and typeface sizes and styles.  
No problem to stamp a small detail, logo, caption.  
No problem even with the most complicated artwork.*





# PHOTO BOOK®

OPUS the binding company

## O.Pouch COVER

The simplest solution for photo book hard cover customisation!

### Customers:

*corporations & private companies,  
public administration & institutions  
photobook makers & photo studios*



OPUS Binding Tower:

- Atlas 190 or Atlas 300
- Coverator 330
- Solid Trimmer 320

**We recommend the OPUS Binding Tower as a workstation for O.Pouch COVER photobook production | see next page ►**



### O. Pouch COVER

Hard cover with a laminating pouch. All you need to do is to print your artwork, trim to fit your O.Pouch COVER and laminate.

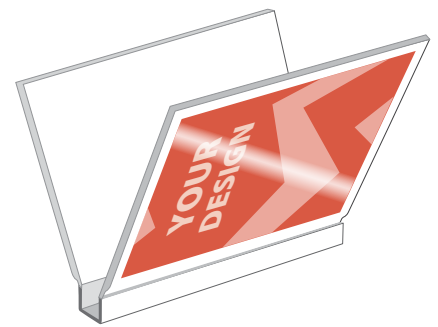

Bind your photo book using OPUS Metalbind System.

OPUS Binding Tower preview	OPUS Binding Tower consists of:	
<p>see the operation video</p>  	 <p><b>OPUS Atlas 190</b> binding machine (see the description on page 5)</p>	 <p><b>OPUS Atlas 300 Image</b> binding machine with ImagePRESS (see page 5)</p>
	 <p><b>OPUS Coverator 330</b> special laminator for O.Pouch covers.</p>	 <p><b>OPUS Trimmer 320</b> to trim the paper before cover lamination</p>

# O.Pouch COVER

## O.Pouch COVER Classic Duplex / O.Pouch COVER Art Duplex

CLASSIC - linen textured hard cover in white or black colour. Front: O.Pouch COVER (with laminating pouch), back: O.Hard Cover Classic.  
 ART - glossy hard cover in white, black\* or silver colour. Front: O.Pouch COVER (with laminating pouch), back: O.Hard Cover Art.

O.Pouch COVER Classic Duplex		O.Pouch COVER Art Duplex		O.CHANNEL Classic		O.CHANNEL Art			
									
Sizes (mm)		Boxed (pcs)		Sizes (mm)		Lenght (mm)		Boxed (pcs)	
304 x 423 (A3+)		20		5 / 7 / 10 / 13 / 16 / 20 / 24 / 28 / 32		304		10	
304 x 304 (square)		20		5 / 7 / 10 / 13 / 16 / 20 / 24 / 28 / 32		304		10	
304 x 212 (A4+)		20		5 / 7 / 10 / 13 / 16 / 20 / 24 / 28 / 32		304		10	
217 x 217 (square)		20		5 / 7 / 10 / 13 / 16 / 20 / 24 / 28 / 32		217		10	
217 x 151 (A5+)		20		5 / 7 / 10 / 13 / 16 / 20 / 24 / 28 / 32		217		10	
217 x 300 (A4 landscape+)		20		5 / 7 / 10 / 13 / 16 / 20 / 24 / 28 / 32		217		10	
155 x 213		20		5 / 7 / 10 / 13 / 16 / 20 / 24 / 28 / 32		217		10	

## SUPPLIES:

### O.Pouch COVER Paper Silver

Special printable paper in silver colour to be used together with O. Pouch COVER Art Silver. Available in suitable formats.

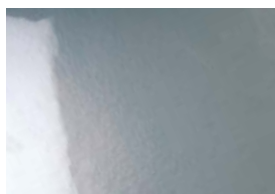

**Note!**

*Ask for more about  
O.Pouch COVER solution*

\* special offer



# PHOTO BOOK®

OPUS the binding company

## Lay-flat photoalbums

to keep The Happiest Days of Our Lives

### Customers:

*photobook makers & photo studios*

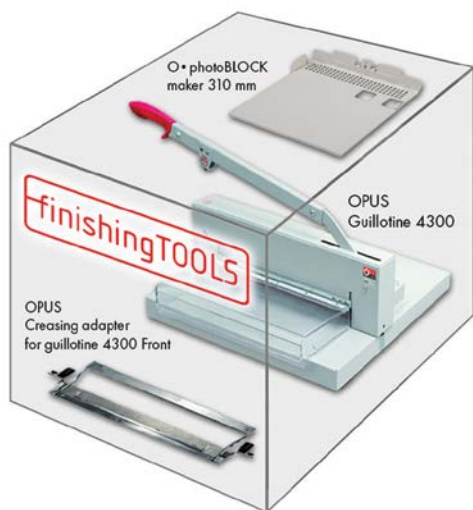

#### OPUS Mounted Photobook Kit 43 Proficut:

- O. PhotoBLOCK maker 310 mm
- Creasing adapter for guillotine 4300
- OPUS guillotine 4300

### Lay-flat Photobooks

Block of pictures mounted in two ways:

- customized soft cover
- customized hard cover

Photolab pages are stuck together and creased to be flat when opening the album. The OPUS Mounted Photobook Kit is a professional workstation to prepare the block & covers and mount the album.

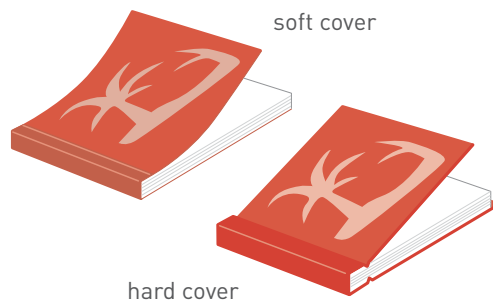

OPUS offers the complete solutions for photobook makers & photo studios.

**We recommend the OPUS Mounted Photobook Kit 43 Proficut as a workstation for lay-flat photobook production | see next page ▶**

OPUS Mounted Photobook Kit 43 Proficut

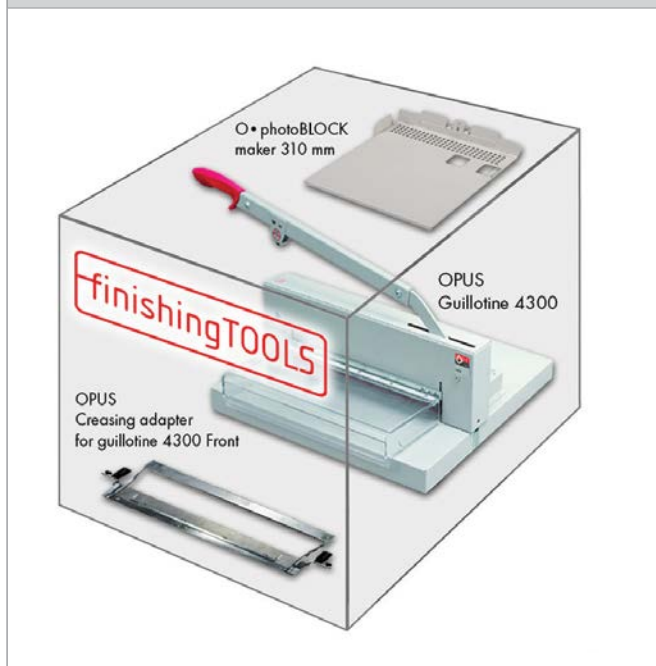

OPUS Mounted Photobook Kit 43 Proficut accessories

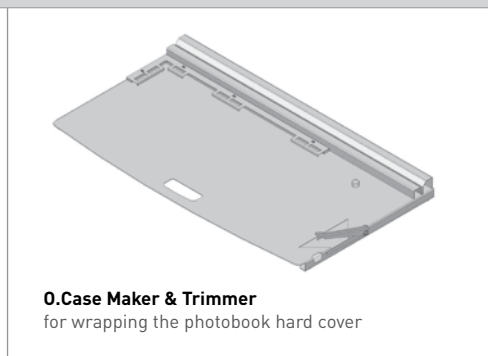
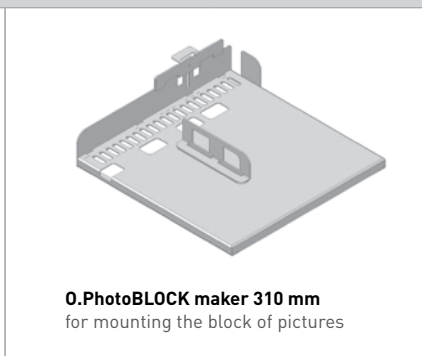

*How to do it?*



*See our tutorials*



Mounted Photobook Kit 43 Proficut



Making of photobook hard cover



**SUPPLIES:**

**O.DSA cardboard**

Special double-sided self-adhesive cardboard to stick together the photolab pictures.



**Note!**

*Ask for available formats and cardboard thicknesses.*



finishingTOOLS

by OPUS the binding company

# Finishing TOUCH

to make your documents  
perfect!

## Customers:

*copy shops & professionals & customers*



MultiCREASE 30

**OPUS - machines & accessories manufacturer**  
MultiCREASE more info | see next page ▶

## OPUS MultiCREASE series

Professional multi-function equipment:

- creases
- perforates
- corner cuts/rounds
- die cuts
- embosses

Choose the version (30 or 52) with 300 or 520 mm working area.



corner cutting

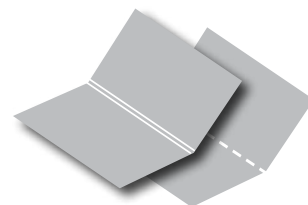

creasing  
/ perforating



thumb cutting  
/ calendar strip  
closing



MultiCREASE 52



MultiCREASE 30

## OPUS MultiCREASE 30

An important multipurpose tool designed for: Offices, Copy / Print shops, Universities and Photographic studios. Enabling: creasing, die-cutting windows in covers, perforating pages.

## OPUS MultiCREASE 52

MultiCREASE with extended working area. You can crease and perforate even 520 mm wide pages. Ask for accessories.

## Technical data

name	MultiCREASE 30	MultiCREASE 52
max working width (mm)	300	<b>520</b>
max thickness of material for creasing and perforating (mm)	0,3	0,3
max creasing and perforating diameter (mm/pt)	0,7 / 2	0,7 / 2
dimensions (H x W x D) mm	270 x 380 x 550	400 x 590 x 550
net weight (kg)	17,5	26
features	- steel frame - metal case	- steel frame - metal case

**Note!** Ask for details.

## ACCESSORIES for MultiCREASE 30 / 52

name	quantity per box
<b>O.Creasing Knife 30</b>	1
<b>O.Creasing Tape 30</b>	5
<b>O.Creasing Kit Multcrease 30 - 2015</b>	1
<b>O.Perforator Bar &amp; Rubber 30</b>	5
<b>O.Perforator Knife 30 - 2015</b>	1
<b>O.Perforator Tape Multcrease 30/52 - 2015</b>	5
<b>O.Perforator Kit Multcrease 30 - 2015</b>	1
<b>O. Corner Cutter R4, MC 30/52</b>	1
<b>O. Corner Cutter R6, MC 30/52</b>	1
<b>O. Corner Cutter R10, MC 30/52</b>	1
<b>O. Corner Cutter C15, MC 30/52</b>	1

name	quantity per box
<b>O.Thumbcut Cutter MC30/52</b>	1
<b>O.Cornecutter PAD MC 30/52 5x190x190 mm</b>	1
<b>O.Creasing Knife 52</b>	1
<b>O.Creasing Tape 52</b>	5
<b>O.Creasing Kit Multcrease 52 - 2015</b>	1
<b>O.Perforator Knife 52</b>	1
<b>O.Perforator Bar &amp; Rubber 52</b>	5
<b>O.Perforator Knife 52 - 2015</b>	1
<b>O.Perforator Kit Multcrease 52 - 2015</b>	1
<b>O.Calendar Strip closer MC 52</b>	1
<b>O.Punch MC30/52 2/27 + 2/63 mm</b>	1



finishingTOOLS

by OPUS the binding company

# Make your own professional wall calendar. The only thing you need is **Multipress 52**

## Two machines in one

Multipress 52 is designed to easily make a thumb cut on the edge of the calendar in preparation for binding them with twin loop wire and a calendar hanger.

Just exchange the punching module for the binding one. In a few minutes the calendar is ready!

## Have a try!

### ● Thumb cut wire binding:

Wall calendar bound by Multipress 52



### IMPORTANT!

Ask for accessories for Multipress 52. Available modules for punching & wire closing (also with thumb cut option)

## NEW!



## OPUS Multipress 52

see the operation video



### Technical data

name	Multipress 52
format max	A3
binds max*	depends on the module used with
binding method	3:1" wire binding
max number of selectable knives	depends on the module used with
dimensions (H x W x D) mm	400 x 590 x 550 mm
net weight (kg)	27,5
features	<ul style="list-style-type: none"> <li>- steel housing</li> <li>- adjustable margin control</li> <li>- paper stop guide</li> </ul>

\* Tested on 80 gsm paper

## OPUS Multipress 52

NEW OPUS multiPRESS 52 is a bookbinding machine designed for office use. It enables punching, thumb cutting and closing of wall calendars.

## Customers:

*copy shops, professionals & offices*

## ACCESSORIES

We offer two kinds of punching/closing modules for Multipress 52 machine (with or without thumb cutter).

module name	preview
<b>O.punch/closer MP52 46 / 3:1" + thumb cut</b>	
<b>O.punch/closer MP52 46 / 3:1"</b>	

## Meet the Multcrease family

*We also recommend the following OPUS equipment for creasing, trimming and cutting.*



OPUS  
Multcrease 30 | 52





the binding company

since 1990

# YOUR customised PRODUCTS

*Everyone is unique.  
That is the reason we offer customised products. Personal covers, matrixes, typefaces. Regardless of the binding system you choose. Would you like something else?*

*Order the ringbinder, offerbox or the presentation box!  
Design it, we will make it!*

<b>RINGBINDER A4 (304 x 212 mm)</b>	spine size (mm)	
method of printing: offset CMYK 4/0	15	30

<b>OFFERBOX A4 (secured by an elastic strap)</b>	spine size (mm)	
method of printing: offset CMYK 4/0	15	30

<b>PRESENTATION BOX A4 (secured by magnets)</b>	spine size (mm)	
method of printing: offset CMYK 4/0	15	30
method of printing: offset CMYK 4/4	15	30

**Note!** Ask for prices and order details.



## OPUS customised products

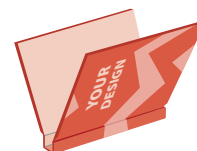

METALBIND, C-BIND, TERBIND covers



Ringbinder



Offerbox



Presentation box

# Your partner in business



the binding company

since 1990



*See our company*



## Innovation & Production